

Cat. No. 12-795
OWNER'S MANUAL

Please read before using this equipment.

Multi-Band AC/DC Portable Radio



RadioShack®

FEATURES

Your RadioShack Multi-Band AC/DC Portable Radio is designed to provide high-quality sound while you listen to up to 10 different radio bands. The portable design lets you use it almost anywhere. Its features include:

Multiple Power Options — let you power the radio with standard AC power using the supplied cord, batteries (not supplied), or your car's cigarette-lighter socket (using an optional DC adapter).

MIC Jack — lets you connect a microphone with a 1/8-inch plug (not supplied) to the radio and hear sound from the microphone through the radio's speaker (like a public address system).

AFC (Automatic Frequency Control) — provides drift-free FM reception and reduced sound distortion.

Carry Strap — easily attaches to the radio so you can carry it with you almost anywhere.



Direction Finder — directional antenna lets you fine-tune the radio to improve AM reception.

Caution: The directional antenna (**DIRECTION FINDER**) on top of the radio is not a handle. To avoid damaging the antenna, do not lift or carry the radio using the antenna. (Use the provided carry strap instead.)

We recommend you record your radio's serial number here. The number is inside the radio's battery compartment.

Serial Number _____

WARNING: To reduce the risk of fire or shock hazard, do not expose this product to rain or moisture.

	CAUTION RISK OF ELECTRIC SHOCK. DO NOT OPEN.	
CAUTION: TO REDUCE THE RISK OF ELECTRIC SHOCK, DO NOT REMOVE COVER OR BACK. NO USER-SERVICEABLE PARTS INSIDE. REFER SERVICING TO QUALIFIED PERSONNEL.		



This symbol is intended to alert you to the presence of unisolated dangerous voltage within the product's enclosure that might be of sufficient magnitude to constitute a risk of electric shock. Do not open the product's case.



This symbol is intended to inform you that important operating and maintenance instructions are included in the literature accompanying this product.

© 1999 Tandy Corporation.
All Rights Reserved.

RadioShack is a registered trademark used by Tandy Corporation.

CONTENTS

Preparation	4
Connecting Power	4
Using AC Power	4
Using Batteries	5
Using Vehicle Battery Power	6
Connecting the Wire Antenna	7
Attaching the Carry Strap	7
Operation	8
Understanding the Bands	8
AM Broadcast	8
Citizen Band	8
Short Wave 1/2	8
FM Broadcast	9
TV Sound 1	9
TV Sound 2	9
VHF Marine	9
Air Craft	9
Weather Band	9
Basic Radio Operation	10
Reading the Tuning/Battery Meter	11
Using the P.A. (Public Address) Function	11
Using the Earphone	12
Listening Safely	12
Traffic Safety	12
Care	13
The FCC Wants You to Know	13
Specifications	15

PREPARATION

CONNECTING POWER

You can power the radio from standard AC power using the supplied power cord, with batteries (not supplied), or from your vehicle's cigarette-lighter socket (using an optional DC adapter).

Caution: Connecting the radio to AC or vehicle battery power disconnects any internal batteries. However, batteries can leak chemicals that can corrode and damage the radio. Always remove the batteries if you:

- will not be using the radio for a week or more
- plan to use only AC or vehicle battery power for a week or more

Using AC Power

You can power the radio using the supplied AC power cord.

Cautions:



You must use the supplied AC power cord. Using any other power cord could damage the radio or the power cord. Contact your local RadioShack store for power cord replacement.

- Always connect the power cord to the radio before you connect it to AC power. When you finish, disconnect the power cord from AC power before you disconnect it from the radio.

Follow these steps to connect AC power.

1. Be sure **POWER** is set to **OFF**, then set **AC/DC** on the back of the radio to **AC**.

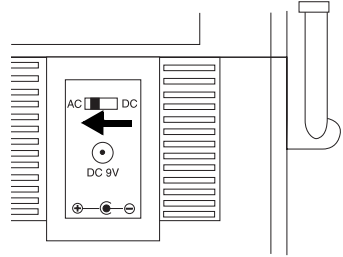

2. Open the battery compartment cover, pull out the power cord, then replace the cover while routing the cord through the slot on the side of the cover.

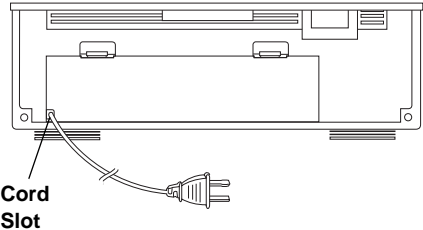

3. Plug the cord into a standard AC outlet.

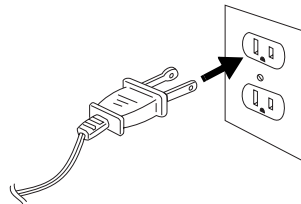

Caution: Your radio's power cord has a polarized plug (one blade is wider than the other). If you have difficulty inserting the plug into the outlet, do not force it! Turn the plug over and try again.

Using Batteries

You can power the radio with four D batteries (not supplied). For the best performance and longest life, we recommend RadioShack alkaline batteries.

Cautions:

- Use only fresh batteries of the required size and recommended type.
- Do not mix old and new batteries, different types of batteries (standard, alkaline, or rechargeable), or rechargeable batteries of different capacities.

Follow these steps to install batteries.

1. Be sure **POWER** is set to **OFF**, then set **AC/DC** on the back of the radio to **DC**.

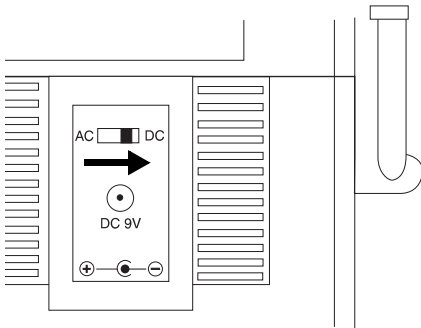

2. Press down the tabs on the battery compartment cover and pull them out to remove the cover.

3. Place four D batteries into the compartment on top of the attached ribbon and according to the polarity symbols (+ and -) marked inside.

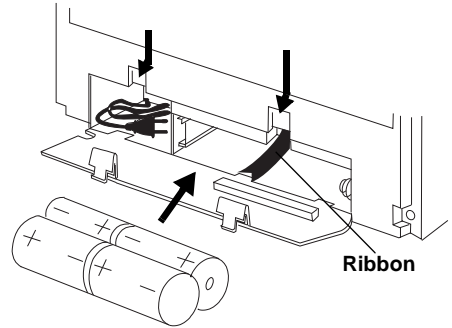

4. Replace the cover.

Replace the radio's batteries when:

- The needle on the **TUNING/BATTERY** meter points toward the left of the green shaded (lower) portion of the meter, when **POWER ON/OFF** is set to **ON** and **RADIO/P.A.** is set to **P.A.** (see "Reading the TUNING/BATTERY Meter" on Page 11).
- Reception weakens or the sound distorts.
- The radio does not operate properly.

Warning: Dispose of old batteries promptly and properly. Do not burn or bury them.

Cautions: If you do not plan to use the radio with batteries for a week or longer, remove the batteries. Batteries can leak chemicals that can destroy electronic parts.

Note: To easily remove the batteries, pull up on the attached ribbon.

Using Vehicle Battery Power

You can power the radio from a vehicle's 12V power source (such as cigarette-lighter socket) using a 9V, 500 mA DC adapter (not supplied) available at your local RadioShack store.

Cautions:



You must use a power source that supplies 9V DC and delivers at least 500 mA. Its center tip must be set to negative and its plug must fit the radio's **DC 9V** jack. Using an adapter that does not meet these specifications could damage the radio or the adapter.

- Always connect the DC adapter to the radio before you connect it to the power source. When you finish, disconnect the adapter from the power source before you disconnect it from the radio.

Follow these steps to connect DC power.

1. Be sure **POWER** is set to **OFF**, and set **AC/DC** on the back of the radio to **DC**.

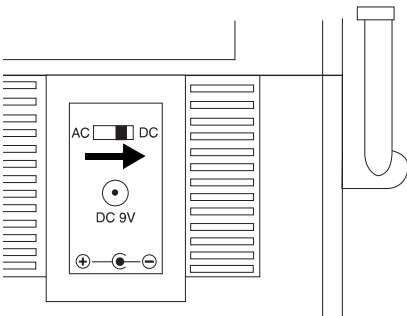

2. Set the adapter's voltage switch to 9V.
3. Insert the adapter's 5.5 mm outer diameter/2.1 mm inner diameter barrel plug into the **DC 9V** jack on the back of the radio.

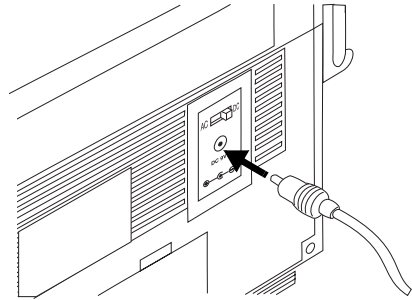

4. Plug the other end of the adapter into the vehicle's cigarette-lighter socket.

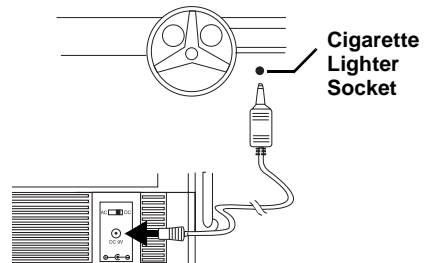

Note: If the radio does not operate when you connect a DC adapter, unplug the adapter from the cigarette-lighter socket and clean any ashes or debris from the socket.

CONNECTING THE WIRE ANTENNA

Besides the **DIRECTION FINDER** antenna and the built-in telescoping antenna, the radio comes with a separate wire antenna (about 10 feet long) for reception when you listen to the shortwave bands (**SW** or **SW2**). To connect the antenna, simply insert the antenna's plug into **ANT** on the front of the radio.

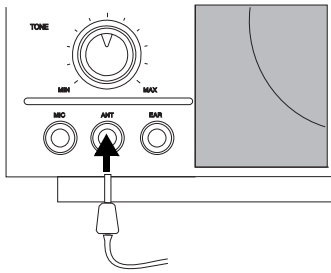

For the best reception when using the wire antenna, fully extend the antenna and run it outside through a window (if possible).

Note: If you lose or damage the supplied wire antenna, you can replace it with a shortwave antenna kit available at your local RadioShack store.

ATTACHING THE CARRY STRAP

The radio comes with a carry strap that you can easily attach and use to carry the radio with you almost anywhere you go. Follow these steps to attach each end of the supplied strap to the hanger bars on the radio.

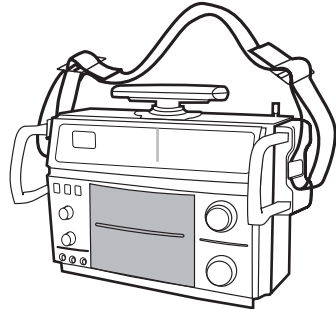

1. Insert one end of the strap into the hanger bar on one side of the radio.
2. Loop the strap end around the bar and pull up on the strap.
3. Insert the strap end into the lower part of the buckle.
4. Pull the strap end through the top of the buckle far enough to stop the strap from slipping.

To shorten the strap for hand carrying, slide the two buckles together.

To lengthen the strap for shoulder carrying, slide the two buckles apart.

OPERATION

UNDERSTANDING THE BANDS

A M BROADCAST	530	600	700	800	1000	1200	1400	1700	kHz			
CITIZEN BAND1			19 23	32 40	CHANNEL			
SHORT WAVE 1	4	4.5	5	6	MHz			
SHORT WAVE 2	7	8	9	10	11	12	MHz	
F M BROADCAST	88	90	92	94	96	100	104	108	MHz	
T V SOUND 1	2	3	4	5	6	CHANNEL	
T V SOUND 2	7	8	9	10	11	12	13	CHANNEL
V H F MARINE	145	155	170	175	MHz
A I R CRAFT	108	115	125	135	MHz
WEATHER BAND	MHz

This radio lets you select from 10 different radio frequency bands. A scale showing the frequency range and tuning position for each band appears to the right of that band's name on the radio's multi-band display.

This section briefly describes the frequency range of each band and the types of communication you can hear when you listen to that band.

AM Broadcast

Frequency Range: 530–1710 kHz

Communications: AM radio stations

Citizen Band

Frequency Range: 26.965–27.405 MHz

Communications: Traffic and road condition announcements, and Channel 19 — the HELP channel, home-to-home, truck-to-truck, dispatchers.

Notes:

- CB reception is limited by range. Some conditions, such as electrical interference, natural obstructions (such as hills), humidity, or atmospheric conditions, could further limit reception.
- For the best CB reception, be sure to fully extend the radio's telescoping antenna.

Short Wave 1/2

Frequency Range:

- SHORT WAVE 1: 4–6 MHz
- SHORT WAVE 2: 7–12 MHz

Communications: Broadcasts from around the world.

Notes:

- Reception varies according to the seasons of the year, the current weather conditions, change in atmosphere and the frequency you selected.
- The best time for listening to short-wave broadcasts is in the evening.

FM Broadcast

Frequency Range: 88–108 MHz

Communications: FM radio stations.

TV Sound 1

Frequency Range: Channels 2–6

Communications: Audio portion of television broadcasts.

TV Sound 2

Frequency Range: Channels 7–13

Communications: Audio portion of television broadcasts.

VHF Marine

Frequency Range: 145–175 MHz

Communications: Public service and marine band frequencies (such as police, fire department, taxi, truck and other private mobile transmissions).

Air Craft

Frequency Range: 108–135 MHz

Communications: Aircraft communications such as aircraft-to-aircraft or between air traffic control and aircraft.

Weather Band

Frequencies:

162.400	162.425	162.450
162.475	162.500	162.525
162.550		

Communications: Weather information broadcasts.

Note: You can generally expect to receive at least one of these channels in your area.

BASIC RADIO OPERATION

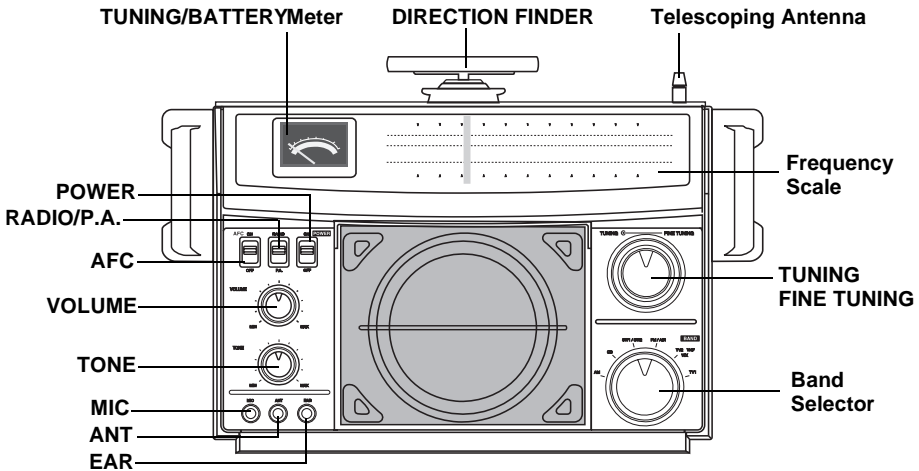

Follow these steps to turn the radio on/off, select a radio band and station/frequency, and adjust the sound.

1. Turn **VOLUME** toward **MIN** until it stops.
2. Set **RADIO/P.A.** to **RADIO**. (To use the P.A. setting, see "Using the P.A. (Public Address) Function" on Page 11.
3. Turn the band selector to the band(s) you want to listen to.
4. If you selected any band other than **AM**, **SW1** or **SW2**, fully extend the telescoping antenna on top of the radio.

If you selected **SW1** or **SW2**, connect the supplied wire antenna to **ANT** on the front of the radio. (See "Connecting the Wire Antenna" on Page 7.)

Note: The radio uses the attached directional antenna (**DIRECTION FINDER**) for AM band reception. The position of the radio's telescoping antenna does not affect AM band reception.

5. For reduced sound distortion and drift-free FM reception, set **AFC** (Automatic Frequency Control) to **ON**.
6. Set **POWER** to **ON** to turn on the radio.
7. Adjust **VOLUME** toward **MAX** to increase the volume, or toward **MIN** to decrease it.
8. Adjust **TONE** to get the sound you like.

9. To select a different station/frequency, rotate **TUNING** (the outside knob) on the front of the radio. The yellow bar on the multi-band scale moves to indicate the current tuning position. The needle on the **TUNING/BATTERY** meter moves toward **10** as the signal strength increases or toward **0** as it decreases (see “Reading the TUNING/BATTERY Meter”).

Notes:

- If you selected the **AM** band, turn **DIRECTION FINDER** (the directional AM antenna) on top of the radio to fine tune the selected AM station.
- If you selected the **SW1** or **SW2** band, rotate **FINE TUNING** (the knob inside **TUNING**) to fine tune the selected SW frequency.

10. To turn off the radio when you finish, set **POWER** to **OFF**.

READING THE TUNING/BATTERY METER

The radio’s **TUNING/BATTERY** meter indicates the current signal strength and the current battery strength (if you installed batteries).

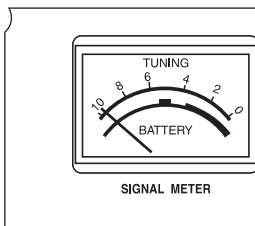

With **POWER** set to **ON** and **RADIO/P.A.** set to **RADIO**, the position of the needle on the top portion of the meter shows the current signal strength on a scale of 0 (weakest signal) to 10 (strongest signal).

With **POWER** set to **ON** and **RADIO/P.A.** set to **P.A.**, the position of the needle on the lower (green-shaded) portion of the meter shows the current battery strength. The needle points toward the right when the battery strength is strong, and moves to the left as the battery strength weakens.

USING THE P.A. (PUBLIC ADDRESS) FUNCTION

Follow these steps to connect a microphone with 1/8-inch (3.5-mm) plug (not supplied) to the radio and set the radio so you can hear sound from the microphone through the radio’s speaker.

Note: Your local RadioShack store carries a wide selection of microphones.

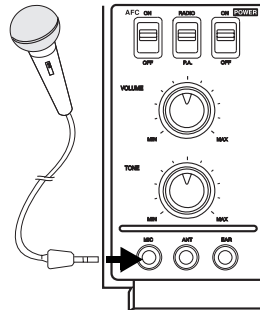

1. Turn **VOLUME** toward **MIN** until it stops.

2. Set **RADIO/P.A.** to **P.A.**
3. Plug the microphone into **MIC** on the front of the radio.
4. Be sure **POWER** is set to **ON**, then speak into the microphone in a normal voice.
5. As you begin speaking, adjust **VOLUME** to a comfortable listening level.

Note: To prevent feedback or high-pitched sounds, keep the microphone pointed away from the radio and stand at least 3 feet away from (behind or beside) the radio.

USING THE EARPHONE

Follow these steps to attach the supplied earphone so you can listen to the radio without disturbing others. Connecting the earphone disconnects the speaker.

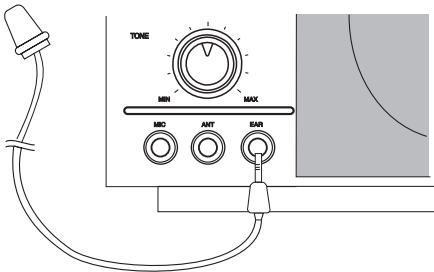

1. Turn **VOLUME** toward **MIN** until it stops.
2. Insert the earphone's 1/8-inch (3.5-mm) plug into the **EAR** jack on the front of the radio.

3. Put the earphone in your ear and adjust **VOLUME** to a comfortable listening level.

Listening Safely

To protect your hearing, follow these guidelines when you use an earphone.

- Set the volume to the lowest setting before you begin listening. After you begin listening, adjust the volume to a comfortable level.
- Do not listen at extremely high volume levels. Extended high-volume listening can lead to permanent hearing loss.
- Once you set the volume, do not increase it. Over time, your ears adapt to the volume level, so a volume level that does not cause discomfort might still damage your hearing.

Traffic Safety

Do not wear an earphone while operating a motor vehicle or riding a bicycle. This can create a traffic hazard and could be illegal in some areas.

Even though some earphones let you hear some outside sounds when listening at normal volume levels, they still can present a traffic hazard.

CARE AND MAINTENANCE

Your RadioShack Multi-Band AC/DC Portable Radio is an example of superior design and craftsmanship. The following suggestions will help you care for your radio so you can enjoy it for years.



Keep the radio dry. If it gets wet, wipe it dry immediately. Liquids might contain minerals that can corrode the electronic circuits.



Use and store the radio only in normal temperature environments. Temperature extremes can shorten the life of electronic devices, damage batteries, and distort or melt plastic parts.



Keep the radio away from dust and dirt, which can cause premature wear of parts.



Handle the radio gently and carefully. Dropping it can damage circuit boards and cases and can cause the radio to work improperly.



Use only fresh batteries of the required size and recommended type. Batteries can leak chemicals that damage your radio's electronic parts.



Wipe the radio with a damp cloth occasionally to keep it looking new. Do not use harsh chemicals, cleaning solvents, or strong detergents to clean the radio.

Modifying or tampering with the radio's internal components can cause a malfunction and might invalidate its warranty and void your FCC authorization to operate it. If your radio is not performing as it should, take it to your local RadioShack store for assistance. [If the trouble is affecting the telephone lines, the phone company can ask you to disconnect your radio until you have resolved the problem.]

FCC DECLARATION OF CONFORMITY

This device complies with Part 15 of the *FCC Rules*. Operation is subject to the following two conditions: (1) this device may not cause harmful interference, and (2) this device must accept any interference received, including interference that may cause undesired operation.

Product:	Multi-Band AC/DC Portable Radio
Model:	12-795
Responsible Party:	RadioShack 100 Throckmorton Fort Worth, TX 76102
Phone:	817-415-3200

THE FCC WANTS YOU TO KNOW

This equipment has been tested and found to comply with the limits for a Class B digital device, pursuant to Part 15 of the *FCC Rules*. These limits are designed to provide reasonable protection against harmful interference in a residential installation. This equipment generates, uses and can radiate radio frequency energy and, if not installed and used in accordance with the instructions, may cause harmful interference to radio communications.

However, there is no guarantee that interference will not occur in a particular installation. If this equipment does cause harmful interference to radio or television reception, which can be determined by turning the equipment off and on, the user is encouraged to try to correct the interference by one or more of the following measures:

- Reorient or relocate the receiving antenna.
- Increase the separation between the equipment and receiver.
- Connect the equipment into an outlet on a circuit different from that to which the receiver is connected.
- Consult your local RadioShack store or an experienced radio/TV technician for help.
- If you cannot eliminate the interference, the FCC requires that you stop using your radio.

Changes or modifications not expressly approved by RadioShack may cause interference and void the user's authority to operate the equipment.

SPECIFICATIONS

Bands

AM	530–1710 kHz
CB (Channels 1–40)	26.965–27.405 MHz
SW1	4.0–6.0 MHz
SW2	7.0–12.0 MHz
FM	88–108 MHz
AIR	108–135 MHz
TV2 (Channels 7–13)	176–218 MHz
VHF	145–175 MHz
WX	162.4–162.55 MHz
TV1 (Channels 2–6)	59.75–87.75 MHz

General

Power Output	900 mW
Power Requirements	AC 120V, 60 Hz, 5 W; 6.0 Volts (Four D Batteries); 9V DC Center Negative
Dimensions (HWD)	$10\frac{1}{4} \times 14\frac{5}{8} \times 5\frac{3}{8}$ Inches (260 × 372 × 136 mm)
Weight	5.53 lbs (2.51 kg)
Antenna	FM Telescoping, Direction Finder
Included Accessories	Wire Antenna (about 10 feet long) Earphone, Carry Strap

Specifications are typical; individual units might vary. Specifications are subject to change and improvement without notice.

Limited Ninety-Day Warranty

This product is warranted by RadioShack against manufacturing defects in material and workmanship under normal use for ninety (90) days from the date of purchase from RadioShack company-owned stores and authorized RadioShack franchisees and dealers. EXCEPT AS PROVIDED HEREIN, RadioShack MAKES NO EXPRESS WARRANTIES AND ANY IMPLIED WARRANTIES, INCLUDING THOSE OF MERCHANTABILITY AND FITNESS FOR A PARTICULAR PURPOSE, ARE LIMITED IN DURATION TO THE DURATION OF THE WRITTEN LIMITED WARRANTIES CONTAINED HEREIN. EXCEPT AS PROVIDED HEREIN, RadioShack SHALL HAVE NO LIABILITY OR RESPONSIBILITY TO CUSTOMER OR ANY OTHER PERSON OR ENTITY WITH RESPECT TO ANY LIABILITY, LOSS OR DAMAGE CAUSED DIRECTLY OR INDIRECTLY BY USE OR PERFORMANCE OF THE PRODUCT OR ARISING OUT OF ANY BREACH OF THIS WARRANTY, INCLUDING, BUT NOT LIMITED TO, ANY DAMAGES RESULTING FROM INCONVENIENCE, LOSS OF TIME, DATA, PROPERTY, REVENUE, OR PROFIT OR ANY INDIRECT, SPECIAL, INCIDENTAL, OR CONSEQUENTIAL DAMAGES, EVEN IF RadioShack HAS BEEN ADVISED OF THE POSSIBILITY OF SUCH DAMAGES.

Some states do not allow the limitations on how long an implied warranty lasts or the exclusion of incidental or consequential damages, so the above limitations or exclusions may not apply to you.

In the event of a product defect during the warranty period, take the product and the RadioShack sales receipt as proof of purchase date to any RadioShack store. RadioShack will, at its option, unless otherwise provided by law: (a) correct the defect by product repair without charge for parts and labor; (b) replace the product with one of the same or similar design; or (c) refund the purchase price. All replaced parts and products, and products on which a refund is made, become the property of RadioShack. New or reconditioned parts and products may be used in the performance of warranty service. Repaired or replaced parts and products are warranted for the remainder of the original warranty period. You will be charged for repair or replacement of the product made after the expiration of the warranty period.

This warranty does not cover: (a) damage or failure caused by or attributable to acts of God, abuse, accident, misuse, improper or abnormal usage, failure to follow instructions, improper installation or maintenance, alteration, lightning or other incidence of excess voltage or current; (b) any repairs other than those provided by a RadioShack Authorized Service Facility; (c) consumables such as fuses or batteries; (d) cosmetic damage; (e) transportation, shipping or insurance costs; or (f) costs of product removal, installation, set-up service adjustment or reinstallation.

This warranty gives you specific legal rights, and you may also have other rights which vary from state to state.

RadioShack Customer Relations, 200 Taylor Street, 6th Floor, Fort Worth, TX 76102

We Service What We Sell

04/99

RadioShack
A Division of Tandy Corporation
Fort Worth, Texas 76102